



BTF13-P1BM2025

HighLine

WIRE DRAW ENCODERS

SICK
Sensor Intelligence.



Illustration may differ



Ordering information

| Type | Part no. |
|----------------|----------|
| BTF13-P1BM2025 | 1060997 |

Included in delivery: MRA-F130-120D1 (1), A3M60B-S1PB013x13 (1)

Product is supplied fully assembled. See individual components for further technical data

Other models and accessories → www.sick.com/HighLine

Detailed technical data

Performance

BTF

| | |
|---|--------------------------|
| Measurement range | 0 m ... 20 m |
| Encoder | Absolute encoders |
| Resolution (wire draw + encoder) | 0.04 mm ^{1) 2)} |
| Repeatability | ≤ 2 mm ³⁾ |
| Linearity | ≤ ± 2 mm ³⁾ |
| Hysteresis | ≤ 5 mm ³⁾ |

¹⁾ The values shown have been rounded.

²⁾ Example calculation based on the BTF08 with PROFINET: 200 mm (wire draw length per revolution - see Mechanical data): 262,144 (number of steps per revolution) = 0.001 mm (resolution of wire draw + encoder combination).

³⁾ Value applies to wire draw mechanism.

Interfaces

BTF

| | |
|----------------------------------|-------------|
| Communication interface | PROFIBUS DP |
| Programmable/configurable | ✓ |

Electrical data

BTF

| | |
|--|--|
| Connection type | Male connector, 2x, M12, 5-pin, axial Female connector, 1x, M12, 5-pin, axial |
| Supply voltage | 10 V ... 32 V |
| Power consumption | ≤ 1.5 W (without load) |
| MTTFd: mean time to dangerous failure | 60 years (EN ISO 13849-1) ¹⁾ |

¹⁾ This product is a standard product and does not constitute a safety component as defined in the Machinery Directive. Calculation based on nominal load of components, average ambient temperature 40°C, frequency of use 8760 h/a. All electronic failures are considered hazardous. For more information, see document no. 8015532.

Mechanical data

BTF

| | |
|---|---|
| Measuring wire material | Highly flexible stranded steel 1,4401 stainless steel V4A |
| Weight (measuring wire) | 2.6 g/m |
| Housing material, wire draw mechanism | Aluminum (anodised), plastic |
| Spring return force | 10 N ... 20 N ¹⁾ |
| Length of wire pulled out per revolution | 332.4 mm |
| Life of wire draw mechanism | Typ. 1,000,000 cycles ^{2) 3)} |
| Actual wire draw length | 20.2 m |
| Wire acceleration | 30 m/s ² |
| Operating speed | 6 m/s |
| Mounted encoder | A3M60 PROFIBUS, A3M60B-S1PB013X13, 1051018 |
| Mounted mechanic | MRA-F130-120D1, 6028628 |

¹⁾ These values were measured at an ambient temperature of 25 °C. There may be variations at other temperatures.

²⁾ Average values, which depend on the application.

³⁾ The service life depends on the type of load. This is influenced by environmental conditions, the installation location, the measuring range in use, the traversing speed, and acceleration.

Ambient data

BTF

| | |
|------------------------------------|--|
| EMC | According to EN 61000-6-2 and EN 61000-6-3 |
| Enclosure rating | IP64 |
| Operating temperature range | -10 °C ... +70 °C |

Classifications





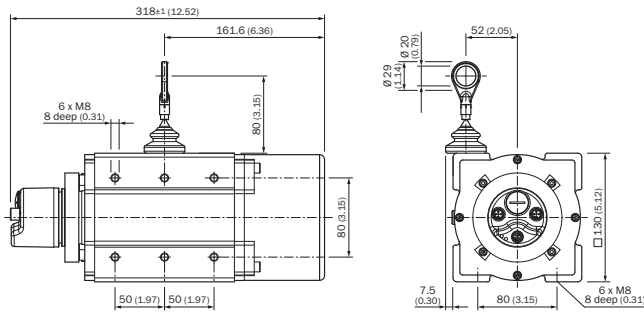

| | |
|-----------------------|----------|
| ECI@ss 5.0 | 27270590 |
| ECI@ss 5.1.4 | 27270590 |
| ECI@ss 6.0 | 27270590 |
| ECI@ss 6.2 | 27270590 |
| ECI@ss 7.0 | 27270590 |
| ECI@ss 8.0 | 27270590 |
| ECI@ss 8.1 | 27270590 |
| ECI@ss 9.0 | 27270590 |
| ECI@ss 10.0 | 27270613 |
| ECI@ss 11.0 | 27270503 |
| ETIM 5.0 | EC001486 |
| ETIM 6.0 | EC001486 |
| ETIM 7.0 | EC001486 |
| UNSPSC 16.0901 | 41112113 |

Dimensional drawing (Dimensions in mm (inch))





Recommended accessories

Other models and accessories → www.sick.com/HighLine

| | Brief description | Type | Part no. |
|---|--|--|----------|
| Flanges | | | |
|  | Flange adapter for HighLine wire draw mechanisms, adaption of face mount flange with centering hub 20 mm to 50 mm servo flange, Aluminum, including 3 countersunk screws M4 x 10 | BEF-FA-020-050WDE | 2073776 |
| Other mounting accessories | | | |
|  | Joint ball for later insertion in wire end ring with 20 mm diameter. The use of this joint ball enables movement in multiple levels of freedom. | Joint protection for wire rope BTF/PRF/MRA | 5318683 |
|  | Compressed air attachment for MRA-F080... and MRA-F130... HighLine wire draw mechanism | MRA-F-P | 6073769 |
|  | Additional brush attachment for wire draw mechanism MRA-F130 (5 m, 10 m, 20 m and 30 m from HighLine series) | MRA-F130-B | 6038562 |
|  | Wire draw deflection pulley for wire draw mechanism MRA-F130 (5m, 10m, 20m and 30m from HighLine series) | MRA-F130-R | 6028631 |
| Plug connectors and cables | | | |
|  | Head A: Flying leads Head B: Flying leads Cable: PROFIBUS DP, PUR, shielded | LTG-2102-MW | 6021355 |
|  | Head A: female connector, M12, 5-pin, angled, A-coded Head B: Flying leads Cable: Sensor/actuator cable, PUR, halogen-free, unshielded, 5 m Voltage supply | DOL-1202-W05MC | 6042067 |
| | Head A: female connector, M12, 5-pin, angled, A-coded Head B: Flying leads Cable: Sensor/actuator cable, PUR, halogen-free, unshielded, 10 m Voltage supply | DOL-1202-W10MC | 6042068 |

| | Brief description | Type | Part no. |
|---|---|--------------------|-----------------|
|  | Head A: female connector, M12, 5-pin, straight, B-coded Head B: Flying leads Cable: PROFIBUS DP, twisted pair, PUR, halogen-free, shielded, 5 m | DOL-1205-G05MQ | 6026006 |
| | Head A: female connector, M12, 5-pin, straight, B-coded Head B: Flying leads Cable: PROFIBUS DP, twisted pair, PUR, halogen-free, shielded, 10 m | DOL-1205-G10MQ | 6026008 |
|  | Head A: female connector, M12, 5-pin, angled, B-coded Head B: Flying leads Cable: PROFIBUS DP, twisted pair, PUR, halogen-free, shielded, 5 m | DOL-1205-W05MQ | 6041423 |
| | Head A: female connector, M12, 5-pin, angled, B-coded Head B: Flying leads Cable: PROFIBUS DP, twisted pair, PUR, halogen-free, shielded, 10 m | DOL-1205-W10MQ | 6041425 |
|  | Head A: male connector, M12, 5-pin, straight, B-coded Head B: Flying leads Cable: PROFIBUS DP, twisted pair, PUR, halogen-free, shielded, 5 m Wire shield Al-Pt film, overall shield C-screen tin-plated | STL-1205-G05MQ | 6026005 |
| | Head A: male connector, M12, 5-pin, straight, B-coded Head B: Flying leads Cable: PROFIBUS DP, twisted pair, PUR, halogen-free, shielded, 10 m Wire shield Al-Pt film, overall shield C-screen tin-plated | STL-1205-G10MQ | 6026007 |
|  | Head A: male connector, M12, 5-pin, angled, B-coded Head B: Flying leads Cable: PROFIBUS DP, twisted pair, PUR, halogen-free, shielded, 5 m | STL-1205-W05MQ | 6041426 |
|  | Head A: male connector, M12, 5-pin, angled, B-coded Head B: Flying leads Cable: PROFIBUS DP, twisted pair, PUR, halogen-free, shielded, 10 m | STL-1205-W10MQ | 6041427 |
|  | Head A: female connector, M12, 5-pin, straight, A-coded Head B: Flying leads Cable: Sensor/actuator cable, PUR, halogen-free, shielded, 5 m | YF2A25-050UB6XLEAX | 2095733 |
| | Head A: female connector, M12, 5-pin, straight, A-coded Head B: Flying leads Cable: Sensor/actuator cable, PUR, halogen-free, shielded, 10 m | YF2A25-100UB6XLEAX | 2095734 |
| | Head A: female connector, M12, 5-pin, straight, A-coded Head B: Flying leads Cable: Sensor/actuator cable, PUR, halogen-free, shielded, 20 m | YF2A25-200UB6XLEAX | 2095738 |
|  | Head A: female connector, M12, 5-pin, straight, B-coded Head B: male connector, M12, 5-pin, straight, B-coded Cable: PROFIBUS DP, twisted pair, PUR, halogen-free, shielded, 10 m Wire shield Al-Pt film, overall shield C-screen tin-plated | DSL-1205-G10MQ | 6032640 |
|  | Head A: female connector, M12, 4-pin, straight Head B: - Cable: unshielded | DOS-1204-G | 6007302 |
|  | Head A: female connector, M12, 4-pin, angled Head B: - Cable: unshielded | DOS-1204-W | 6007303 |
|  | Head A: female connector, M12, 5-pin, straight, B-coded Head B: - Cable: PROFIBUS DP, shielded | DOS-1205-GQ | 6021353 |
|  | Head A: female connector, M12, 5-pin, angled, B-coded (B-reverse) Head B: - Cable: PROFIBUS DP, PROFIBUS DP, shielded | DOS-1205-WQ | 6041429 |
|  | Head A: male connector, M12, 5-pin, straight, B-coded Head B: - Cable: PROFIBUS DP, shielded | STE-1205-GQ | 6021354 |

| | Brief description | Type | Part no. |
|---|--|----------------|----------|
|  | Head A: male connector, M12, 5-pin, angled, B-coded Head B: - Cable: PROFIBUS DP, shielded | STE-1205-WQ | 6041428 |
|  | Cable: unshielded, set of connectors Head A: male connector, M12, 4-pin, straight, B-coded Cable: PROFIBUS DP, terminal resistor | DOS-3XM12-W | 2058177 |
| Wire draw mechanism | | | |
|  | HighLine wire draw mechanism for servo flange with 6 mm shaft, measuring range 0 m ... 20 m | MRA-F130-120D1 | 6028628 |

SICK AT A GLANCE

SICK is one of the leading manufacturers of intelligent sensors and sensor solutions for industrial applications. A unique range of products and services creates the perfect basis for controlling processes securely and efficiently, protecting individuals from accidents and preventing damage to the environment.

We have extensive experience in a wide range of industries and understand their processes and requirements. With intelligent sensors, we can deliver exactly what our customers need. In application centers in Europe, Asia and North America, system solutions are tested and optimized in accordance with customer specifications. All this makes us a reliable supplier and development partner.

Comprehensive services complete our offering: SICK LifeTime Services provide support throughout the machine life cycle and ensure safety and productivity.

For us, that is “Sensor Intelligence.”

WORLDWIDE PRESENCE:

Contacts and other locations –www.sick.com